

crystal

crystal

slim geometry

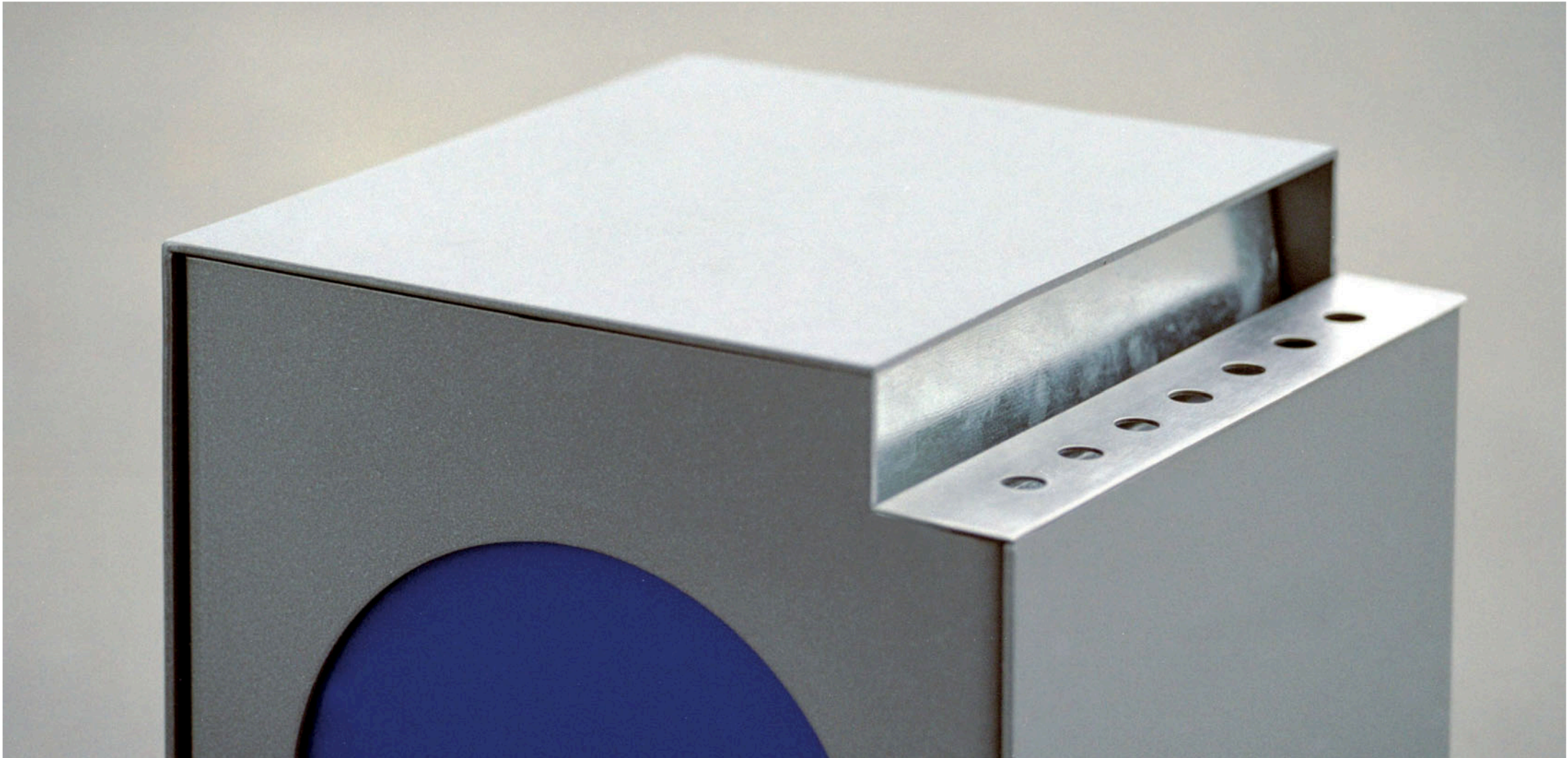

crystal

A fully enclosed all-steel litter bin of geometric shape and steadily firm construction evokes the impression of a rather elegant bollard. The triple litter bin for sorted waste is a variation which is in constant demand. Moreover, the version for the collection of dog excrements with integrated space for special plastic bags smartly addresses the current problem experienced by most contemporary cities. For smokers, a large ashtray is now available.

Galvanized steel structure painted with powder coating finish. Stainless steel cigarette extinguisher with ashtray in the top part of the bin. Galvanized steel inner bin. Forward opening lockable door. Possibility of anchoring to concrete base.

crystal



crystal



crystal



crystal



crystal



crystal



crystal



crystal



crystal



n – stainless steel

 drop-in area without cover

 drop-in area with cover

CS110 / 111 / 210 / 211

Litter bin

steel body, ashtray with stainless steel cigarette extinguisher

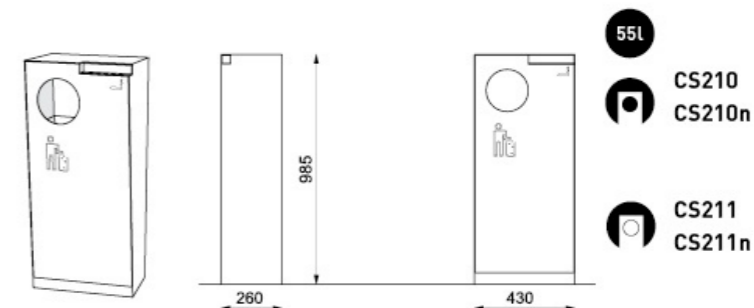
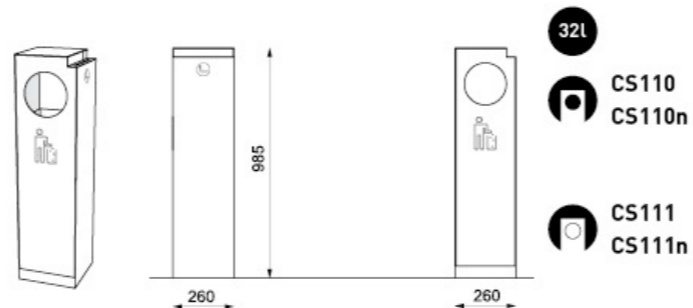

CS330 / 331 / 350 / 351

Triple litter bin for sorted waste

steel body, ashtray with stainless steel cigarette extinguisher

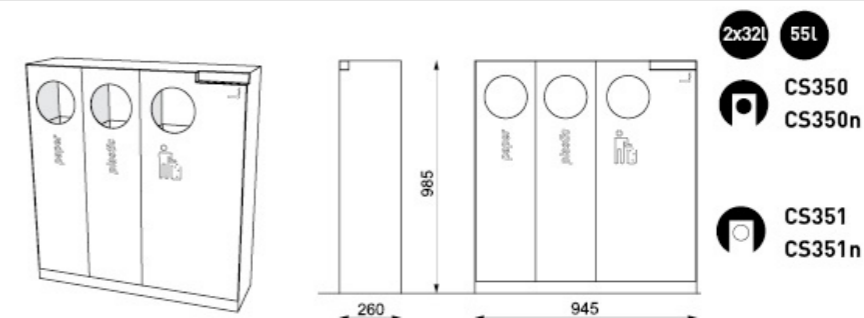
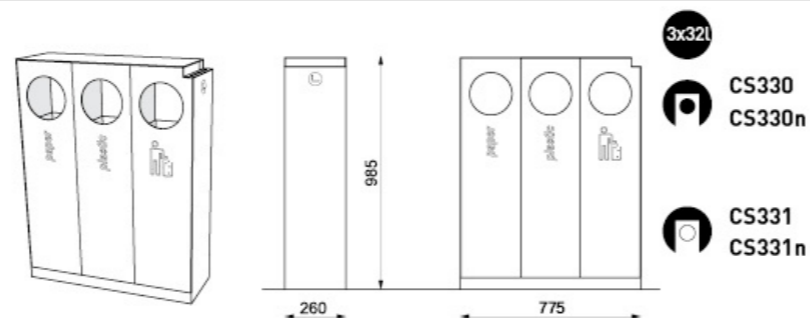

CP110

Special litter bin for dog excrements

steel body, integrated space for plastic bags



CSP120

Ashtray

standard or stainless steel body with cigarette extinguisher

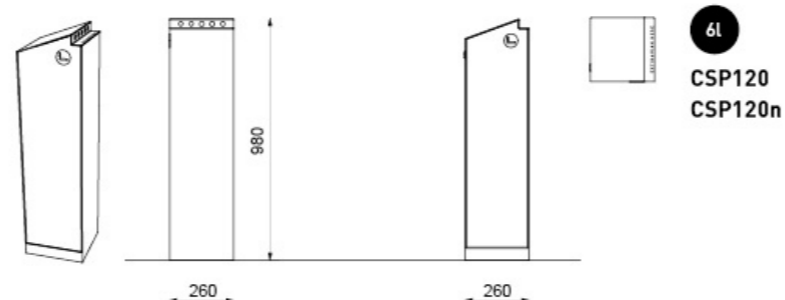

crystal

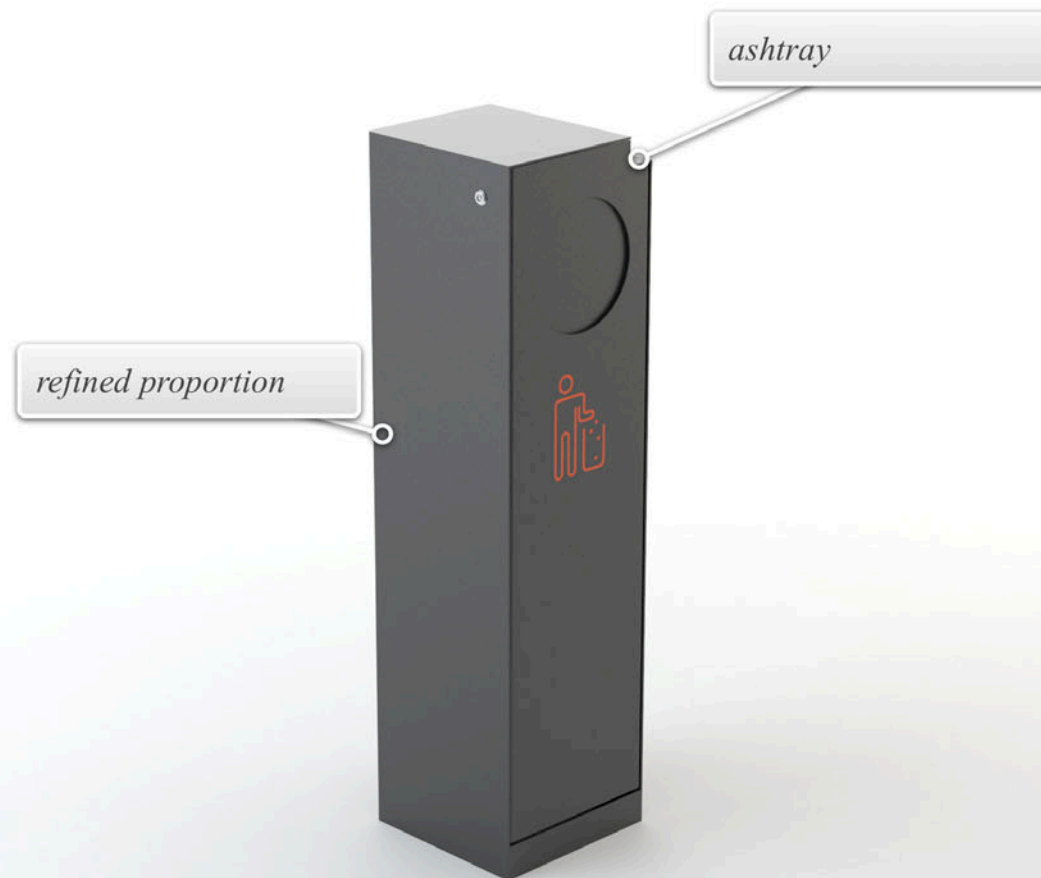

crystal



crystal

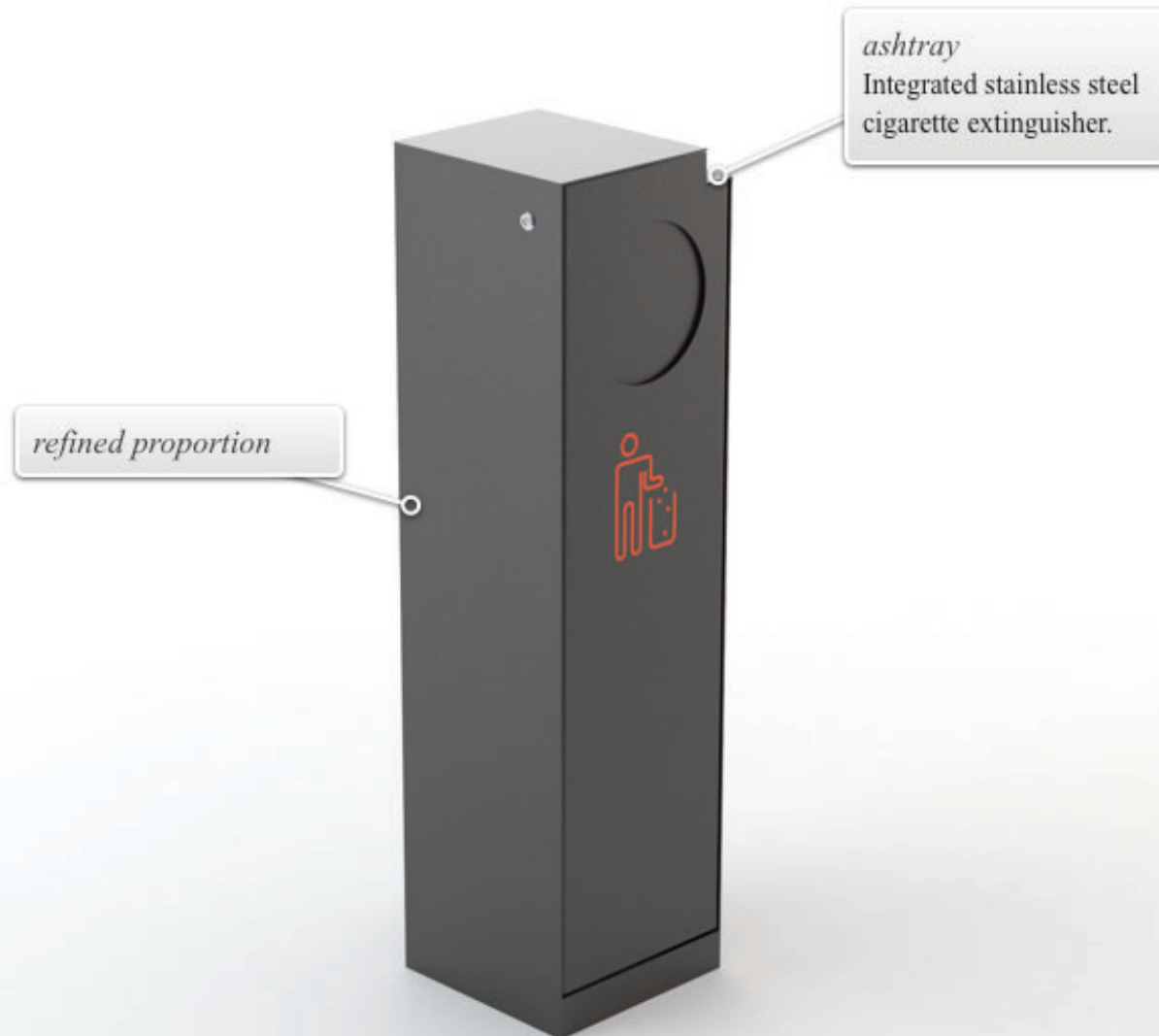

KOTVENÍ NA DLAŽBU
ANCHORING ON THE PAVEMENT
VERANKERUNG AN PFLASTER

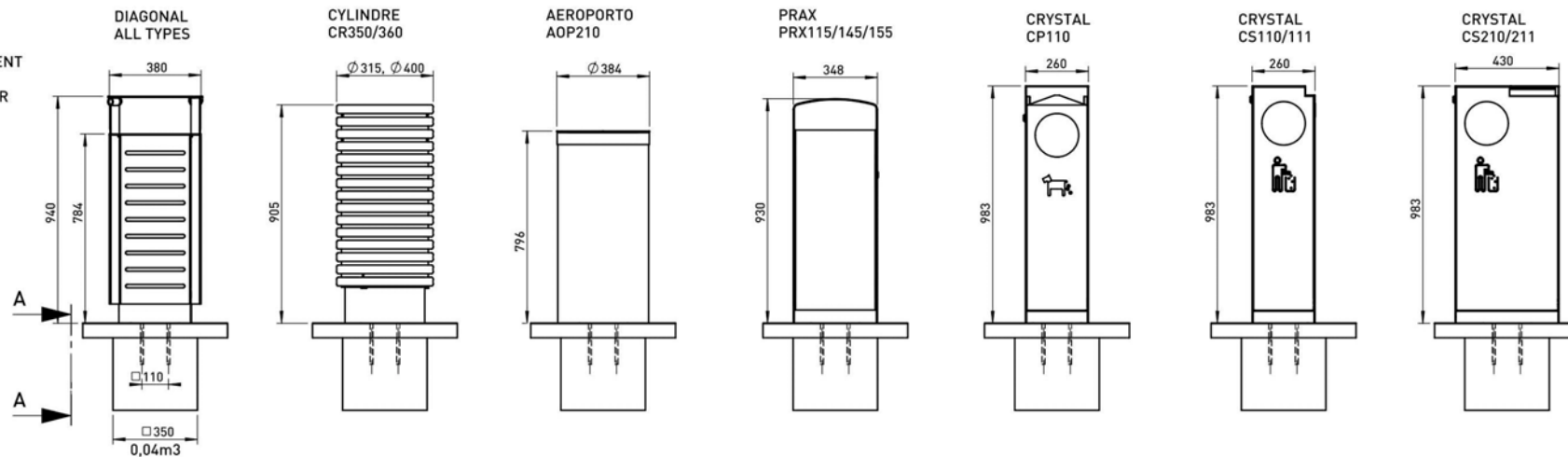

M10
DIN 934

M10
DIN 127 B

M10 Ø 30
DIN 9021

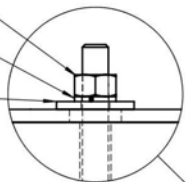

A-A

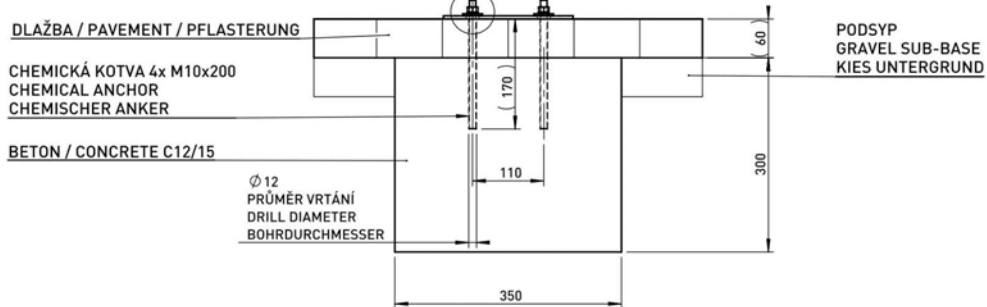

DIAGONAL
DG610/615/710/715

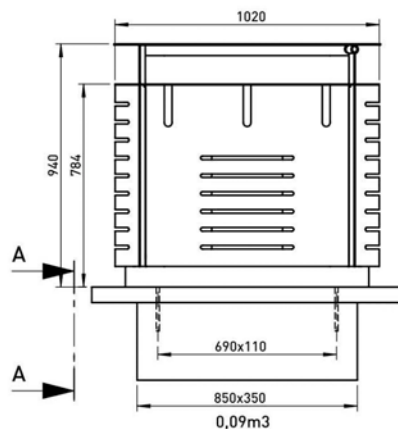

CRYSTAL
CS330/331

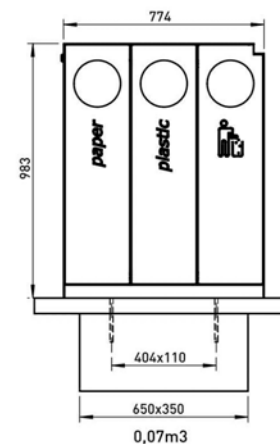

CRYSTAL
CS350/351

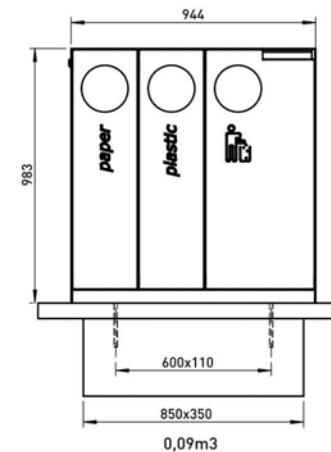

TECHNICAL SPECIFICATIONS 3/5
TYP B - LITTER BINS



Rozměry výrobků mají informativní charakter. Výrobce si vyhrazuje právo na změnu technické specifikace bez předchozího upozornění. Rozměry spodní stavby a způsob osazení výrobku jsou závazné. Rozměry kotvení měřte podle rozměrů dodaného výrobku.
All product sizes have an informative character. The Producer reserves the right to amend the technical specification at any time without previous warning. The size of foundation baseplate and the method of mounting of the product are imperative. Anchor spacing measure out by measurements of supplied product.
Die Abmessungen der Produkte sind informativ. Der Hersteller behält sich das Recht an Änderungen der technischen Spezifikationen vor, ohne vorher darauf hinzuweisen. Abmessungen der Fundamentierung - Unterbau und Art des Produkteinbaus sind verbindlich. Ankerabstand gemäß der gelieferten Produktabmessungen dimensionieren.

mmcite.com