



225.F380 2M20 2,0m-CPR-2024.02.02

Utført av JSK - Godkjent for produsent av Dag Riise 02.02.2024

Produkt:	ST portalfundament 380x380 2M20 2.0m
Produkt nummer:	22595001310
Påtenkt bruk:	Fundament til Saferoad trafikkportal
Harmonised Standard:	EN 14991:2007
Produsent / Plassert på markedet av:	Saferoad Traffic AS Paul A. Owrens veg 46, 2607 Vingrom, Norway
Produsert på fabrikk:	Skjæveland Gruppen AS, N-4323 Sandnes, Norway
Beregningsmetode:	Broms metoden (Bengt B. Broms)
Teknisk spesifikasjon: Harmonisert standard NS EN 14991:2007	<p>Fundamentet produseres i hht. betongstandard NS-EN 206-1</p> <p>Betong: Fasthetsklasse NS B-55 med sluttresultat $f_{ck} = 67 \text{ N/mm}^2$, testet på terning 100x100mm. Eksponeringsklasse XD 1, 2, 3. Testet på sylinder skal sluttresultatet være min. 55 N/mm^2.</p> <p>Sementmengde min. 300 kg pr m^3. Masseforhold maks. M-45.</p> <p>Vannabsorpsjon: Etter 30 m. maks. 3,0 %. Etter 24 t. maks. 5,0 %.</p> <p>Armering: B500SP / B500B, $f_{tk} = 600 \text{ N/mm}^2$, $f_{yk} = 500 \text{ N/mm}^2$</p> <p>Fotplater og hjørnstag: S355J2</p> <p>Varmforsinket iht. EN ISO 1461, klass Fe/Zn 115μm</p> <p>Armering, Ytelseserklæring: 225.A380 2M20 2,0m-CPR-2023.06.06</p> <p>Løfteanker: 2 stk. Congrip (4,0) 3-065G</p> <p>Festemateriell, varmforsinkede bolter som leveres med fundamentet:</p> <p>8 stk. M20x90mm 6kt.bolt ISO4014, VZN SB 8.8</p> <p>16 stk. M20 Skive ISO 7089, VZN 8.8</p> <p>16 stk. M20 Skive ISO 7089, VZN 8.8</p> <p>Festemateriell, bolter i kvalitet A4-80 kan bestilles til/med fundamentet.</p>
Vekt:	1238,7 kg
Produksjonsgrunnlag:	Saferoad Traffic AS produkt nr.: 22595001310 Tegningsnr.: 10002436 (Armering, Tegningsnr.: 10002437)
Montering:	Se monteringsveiledning på saferoad.no/mv/225 Samt illustrasjoner med mål på side 2.
Drift / Vedlikehold:	Varmforsinkede fundamentbolter kontrolleres og skiftes ev. ut ved behov, ca. hvert 10:e år. Intet vedlikehold dersom A4-80 bolter brukes.
Systemer for vurdering og kontroll, CE merking:	Fundamentet er CE merket i hht. EN 14991:2007, se vedlegg. Notified body nr. 1111, Kontrollrådet , se vedlagt sertifikat. System for attestering av samsvar: System 2+
Merking:	<p>På stål: 380-2M20-2,0mSTÅÅSP##### (ÅÅ = prod.år, ##### = SP internt order nr.)</p> <p>På betong: ST 22595001310 380x380 2M20 2,0m 1,3t</p> <div style="display: flex; align-items: center; justify-content: center;">   </div>

225.F380 2M20 2,0m-CPR-2024.02.02

Utført av JSK - Godkjent for produsent av Dag Riise 02.02.2024

ST portalfundament 380x380 2M20 2.0m

Prefabrikkert 2,0m betongfundament for portal

2M20 betegner at det benyttes 2 stk. M20 bolter i hvert hjørne, 8 stk. bolter totalt

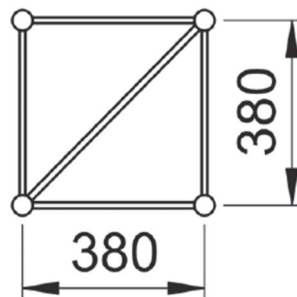
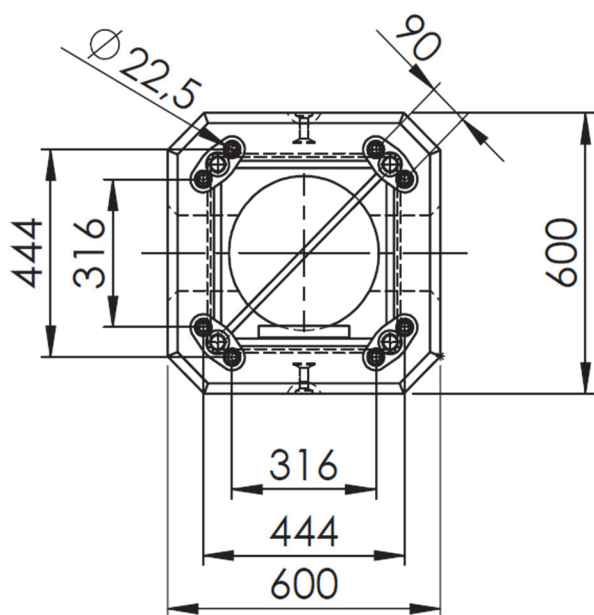
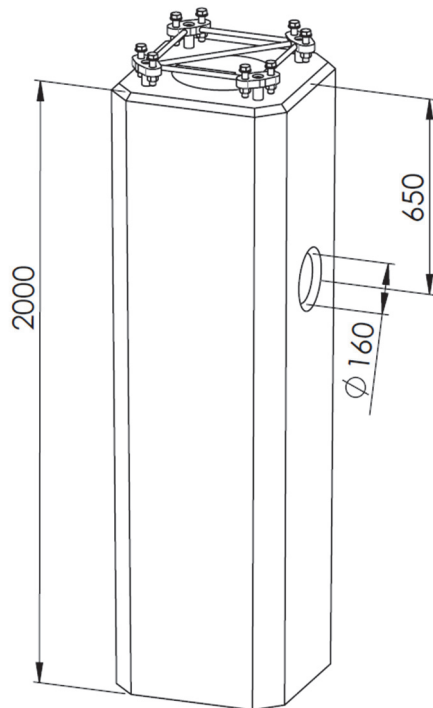



Ytelseserklæring:
saferoad.no/ye/225/Fund



Monteringsveiledning:
saferoad.no/mv/225

Saferoad Traffic AS

Paul A. Owrens veg 46
2607 Vingrom
+47 61 24 80 50
www.saferoad.no

20

225.F380 2M20 2,0m-CPR-2024.02.02

NS EN 14991:2007

ST portalfundament 380x380 2M20 2.0m

Vekt: 1238,7 kg

Betong: NS B-55,

$$f_{ck} = 67 \text{ N/mm}^2$$

Armering: B500SP / B500B

$$f_{yk} = 500 \text{ N/mm}^2$$

$$f_{tk} = 600 \text{ N/mm}^2$$

Fotplater og hjørnstag: S355J2

Varmforsinket iht. EN ISO 1461, klass Fe/Zn 115µm

Tegningsnummer: 10002436

ST Produktnummer: 22595001310

Armering, Tegningsnummer: 10002437

Armering, ST Produktnummer: 22590002310

Armering Ytelseserklæring:

225.A380 2M20 2,0m-CPR-2023.06.06

Merking stål: 380-2M20-2,0mSTÅÅSP####



CERTIFICATE

Conformity of the Factory Production Control

1111-CPR-0558

In compliance with Regulation 305/2011/EU of the European Parliament and of the Council of 9 March 2011 (the Construction Products Regulation or CPR), this certificate applies to the construction product

Precast concrete products. Foundations : EN 14991 : 2007

Precast concrete foundationproducts: Euroskilt Bommer, Portaler, Halvportaler Norsafe® Mast Optimized foundations Low type 1, types: F-NM89-7.5L; F-NM120-15L; F-NM150-30L; F-NM190-45L; F-NM190-60L; F-NM290-100L and Norsafe® Mast foundations High type 2, types: F-NM89-7.5H; F-NM120-15H; F-NM150-30H; F-NM190-45H; F-NM190-60H; F-NM290-100H

Produced by or for

Saferoad Traffic AS

Paul A Owrens Veg 46

N - 2607 Vingrom, Norway

and produced in manufacturing plant(s)

Skjæveland Gruppen AS, N-4323 Sandnes, Norway

This certificate attests that all provisions concerning the assessment and verification of constancy of performance described in Annex ZA of the standard(s)

EN 14991:2007

under system 2+ are applied and that the factory production control fulfils all the prescribed requirements set out above.

This certificate was first issued on 06.01.13 and will remain valid as long as the test methods and/or factory production control requirements included in the harmonised standard, used to assess the performance of the declared characteristics, do not change, and the product, and the manufacturing conditions in the plant are not modified significantly. The certificate will expire at the latest **30.09.25**.

Oslo, 19. January 2024

Certification Manager