



## 225.F580 2M30 2,5m-CPR-2024.02.02

Utført av JSK - Godkjent for produsent av Dag Riise 02.02.2024

<b>Produkt:</b>	<b>ST portalfundament 580x450 2M30 2.5m</b>
<b>Produkt nummer:</b>	22595001460
<b>Påtenkt bruk:</b>	Fundament til Saferoad trafikkportal
<b>Harmonised Standard:</b>	EN 14991:2007
<b>Produsent / Plasseret på markedet av:</b>	Saferoad Traffic AS Paul A. Owrens veg 46, 2607 Vingrom, Norway
<b>Produsert på fabrikk:</b>	Skjæveland Gruppen AS, N-4323 Sandnes, Norway
<b>Beregningsmetode:</b>	Broms metoden (Bengt B. Broms)
<b>Teknisk spesifikasjon: Harmonisert standard NS EN 14991:2007</b>	<p>Fundamentet produseres i hht. betongstandard NS-EN 206-1</p> <p>Betong: Fasthetsklasse NS B-55 med sluttresultat <math>f_{ck} = 67 \text{ N/mm}^2</math>, testet på terning 100x100mm. Eksponeringsklasse XD 1, 2, 3. Testet på sylinder skal sluttresultatet være min. <math>55 \text{ N/mm}^2</math>.</p> <p>Sementmengde min. 300 kg pr <math>\text{m}^3</math>. Masseforhold maks. M-45.</p> <p>Vannabsorpsjon: Etter 30 m. maks. 3,0 %. Etter 24 t. maks. 5,0 %.</p> <p>Armering: B500SP / B500B, <math>f_{tk} = 600 \text{ N/mm}^2</math>, <math>f_{yk} = 500 \text{ N/mm}^2</math></p> <p>Fotplater og hjørnstag: S355J2</p> <p>Varmforsinket iht. EN ISO 1461, klass Fe/Zn 115<math>\mu\text{m}</math></p> <p>Armering, Ytelseserklæring: 225.A580 2M30 2,5m-CPR-2023.06.06</p> <p>Løfteanker: 2 stk. Congrip (4,0) 3-065G</p> <p>Festemateriell, varmforsinkede bolter som leveres med fundamentet:</p> <p>8 stk. M30x120mm 6kt.bolt ISO4014, VZN SB 8.8</p> <p>16 stk. M30 Skive ISO 7089, VZN 8.8</p> <p>16 stk. M30 Skive ISO 7089, VZN 8.8</p> <p>Festemateriell, bolter i kvalitet A4-80 kan bestilles til/med fundamentet.</p>
<b>Vekt:</b>	2883,2 kg
<b>Produksjonsgrunnlag:</b>	Saferoad Traffic AS produkt nr.: 22595001460 Tegningsnr.: 10002448 (Armering, Tegningsnr.: 10002449)
<b>Montering:</b>	Se monteringsveiledning på <a href="http://saferoad.no/mv/225">saferoad.no/mv/225</a> Samt illustrasjoner med mål på side 2.
<b>Drift / Vedlikehold:</b>	Varmforsinkede fundamentbolter kontrolleres og skiftes ev. ut ved behov, ca. hvert 10:e år. Intet vedlikehold dersom A4-80 bolter brukes.
<b>Systemer for vurdering og kontroll, CE merking:</b>	Fundamentet er CE merket i hht. EN 14991:2007, se vedlegg. <b>Notified body nr. 1111, Kontrollrådet</b> , se vedlagt sertifikat. System for attestering av samsvar: System 2+
<b>Merking:</b>	<p><b>På stål:</b> 580-2M30-2,5mSTÅÅSP##### (ÅÅ = prod.år, ##### = SP internt order nr.)</p> <p><b>På betong:</b> <b>ST 22595001460</b> <b>580x450 2M30</b> <b>2,5m 3,0t</b></p> <div style="display: flex; align-items: center; justify-content: center;">   </div>

225.F580 2M30 2,5m-CPR-2024.02.02

Utført av JSK - Godkjent for produsent av Dag Riise 02.02.2024

## ST portalfundament 580x450 2M30 2.5m

Prefabrikkert 2,5m betongfundament for portal

2M30 betegner at det benyttes 2 stk. M30 bolter i hvert hjørne, 8 stk. bolter totalt

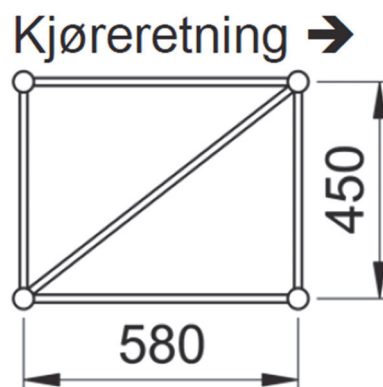
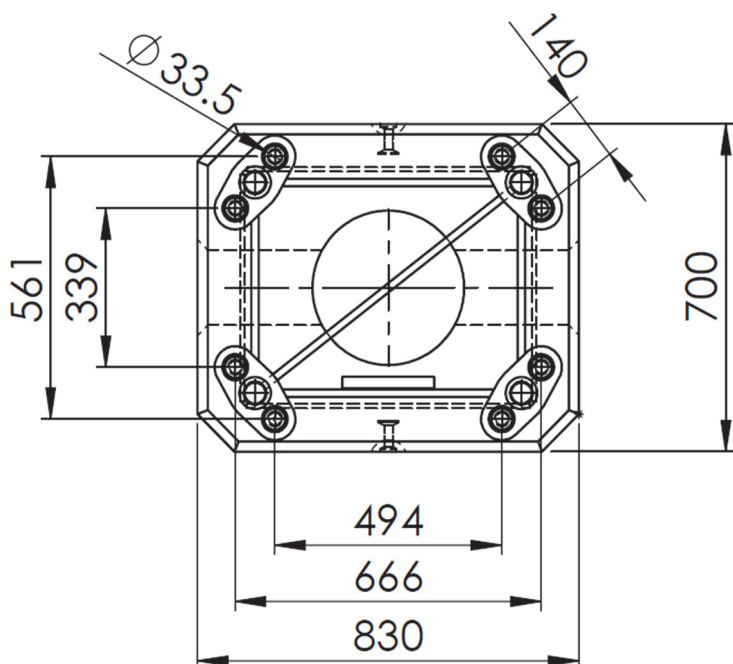
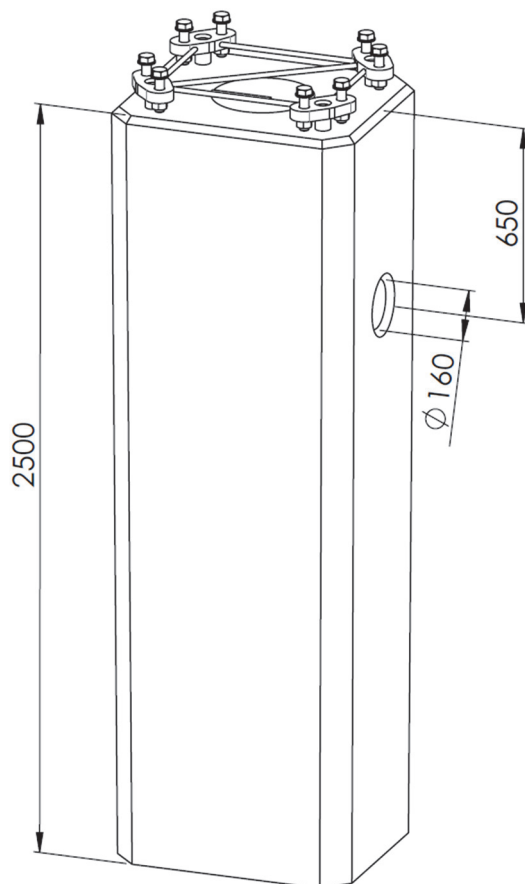



Ytelseserklæring:  
saferoad.no/ye/225/Fund



Monteringsveiledning:  
saferoad.no/mv/225

## Saferoad Traffic AS

Paul A. Owrens veg 46  
2607 Vingrom  
+47 61 24 80 50  
www.saferoad.no

20

225.F580 2M30 2,5m-CPR-2024.02.02

NS EN 14991:2007

### ST portalfundament 580x450 2M30 2.5m

Vekt: 2883,2 kg

Betong: NS B-55,

$$f_{ck} = 67 \text{ N/mm}^2$$

Armering: B500SP / B500B

$$f_{yk} = 500 \text{ N/mm}^2$$

$$f_{tk} = 600 \text{ N/mm}^2$$

Fotplater og hjørnestag: S355J2

Varmforsinket iht. EN ISO 1461, klass Fe/Zn 115µm

Tegningsnummer: 10002448

ST Produktnummer: 22595001460

Armering, Tegningsnummer: 10002449

Armering, ST Produktnummer: 22590002460

Armering Ytelseserklæring:

225.A580 2M30 2,5m-CPR-2023.06.06

Merking stål: 580-2M30-2,5mSTÅÅSP####



## CERTIFICATE

### Conformity of the Factory Production Control

**1111-CPR-0558**

In compliance with Regulation 305/2011/EU of the European Parliament and of the Council of 9 March 2011 (the Construction Products Regulation or CPR), this certificate applies to the construction product

**Precast concrete products. Foundations : EN 14991 : 2007**

**Precast concrete foundationproducts: Euroskilt Bommer, Portaler, Halvportaler Norsafe® Mast Optimized foundations Low type 1, types: F-NM89-7.5L; F-NM120-15L; F-NM150-30L; F-NM190-45L; F-NM190-60L; F-NM290-100L and Norsafe® Mast foundations High type 2, types: F-NM89-7.5H; F-NM120-15H; F-NM150-30H; F-NM190-45H; F-NM190-60H; F-NM290-100H**

Produced by or for

**Saferoad Traffic AS**

**Paul A Owrens Veg 46**

**N - 2607 Vingrom, Norway**

and produced in manufacturing plant(s)

**Skjæveland Gruppen AS, N-4323 Sandnes, Norway**

This certificate attests that all provisions concerning the assessment and verification of constancy of performance described in Annex ZA of the standard(s)

**EN 14991:2007**

under system 2+ are applied and that the factory production control fulfils all the prescribed requirements set out above.

This certificate was first issued on 06.01.13 and will remain valid as long as the test methods and/or factory production control requirements included in the harmonised standard, used to assess the performance of the declared characteristics, do not change, and the product, and the manufacturing conditions in the plant are not modified significantly. The certificate will expire at the latest **30.09.25**.

Oslo, 19. January 2024

Certification Manager